

HISTON STREET LIGHT 3000K/4000K 120W

NET-33-20-54

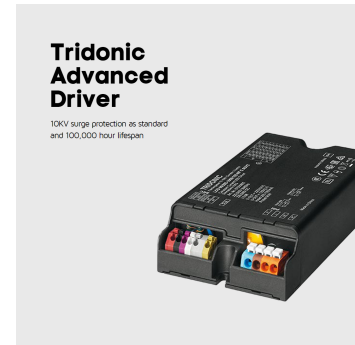

Features & Benefits

- Choose between two different colour temperatures (3000K or 4000K) at the time of installation
- Built-in, energy saving Virtual Midnight function - dim at the mid-point of sunset to sunrise to save additional energy
- Tridonic driver with 10KV surge protection and 100,000 hour lifespan
- Specialist lens for improved uniformity and larger light distribution
- Slip fitter included for use on 60 or 70mm pole
- Choose between two different mounting options (horizontal or vertical) with the adjustable spigot

Key Data

Power	120W
Luminous Flux	17640lm
Colour Temperature	3000K/4000K
IP Rating	IP66
IK Rating	IK08
Dimensions	Ø745 x 282 x 137mm
Warranty	5 Years (Registration Required)

Compatible Accessories

NET-23-20-08	3 Pin NEMA Photocell Sensor for Histon Street Lights
NET-23-16-51	Double Outreach Arm Bracket
NET-23-16-53	Flat Wall Bracket

NET LED Lighting

Buckingham Business Park, 300 Anderson Road,
 Swavesey, Cambridge, CB24 4UQ

T: 01223 851505 | sales@netled.co.uk | www.netled.co.uk



ORDER BY 6PM
 FOR NEXT DAY DELIVERY

Technical Specifications

Input Voltage (AC)	220-240V
Power Factor	0.98
Luminaire Efficacy	147lm/W
LED Manufacturer	Luxeon
LED Type	EMC 5050
No. of LEDs	96
Driver Manufacturer	Tridonic
Driver Output Voltage (DC)	130V (LV)
Total Circuit Power (W)	120W
Electrical Class	1
Colour Rendering	>70 CRI
Lamp Viewing Angle	140° x 70°
Dimmable	Virtual Midnight
Operating Temp.	-15°C to +40°C
Lifespan LM80	50,000 Hours
Weight	6.1Kg
Manufacturer	NET LED Lighting
Photocell Compatible	Yes - 3 Pin NEMA
Housing Colour	Grey
Housing Material	Aluminium Alloy
Diffuser Material	Glass
Dimming Input Type	NFC Programmed
Column Entry	60mm/76mm

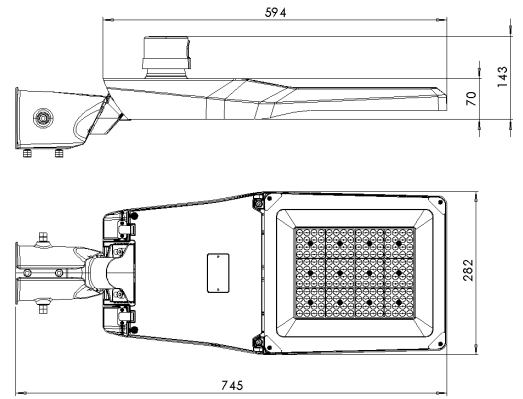

Other Options

Description	
NET-33-20-50	Histon Street Light 3000K/4000K 30W
NET-33-20-51	Histon Street Light 3000K/4000K 50W
NET-33-20-52	Histon Street Light 3000K/4000K 80W
NET-33-20-53	Histon Street Light 3000K/4000K 100W
NET-33-20-54	Histon Street Light 3000K/4000K 120W

NET LED Lighting

Buckingham Business Park, 300 Anderson Road,
Swavesey, Cambridge, CB24 4UQ



ORDER BY 6PM
FOR NEXT DAY DELIVERY

T: 01223 851505 | sales@netled.co.uk | www.netled.co.uk

3K

4K

SELECTABLE COLOUR TEMPERATURE

Choose your colour temperature 3000K or 4000K

OPTIONAL 3 PIN NEMA PHOTOCELL SENSOR

Reduce energy costs and ensure the fitting comes on only when required

SPECIALIST LENS

Create a Batwing Beam Angle for improved uniformity and larger light distribution

ADJUSTABLE SPIGOT

Adjust the head in 5° increments from -15° to +15°

TRIDONIC DRIVER WITH 10KV SURGE PROTECTION AND BUILT-IN OPTIONAL VIRTUAL MIDNIGHT FUNCTION

Dim the fitting at the mid-point of sunset to sunrise to save additional energy