

Safety Information

> All electrical work must be undertaken by a qualified contractor to ensure compliance with latest edition BS7671 and IEE/IET wiring regulations.

> Before installing a Bulkhead or doing any maintenance, ensure power supply is turned off at the circuit breaker or fuse box.

> This product is designed for permanent connection to fixed wiring; the circuit should be protected with the appropriate MCB or fuse.

Environment

> Please DO NOT dispose of electrical items or packaging as unsorted waste. Use the recycling facilities provided by your local authorities.

PRODUCT DIMENSIONS

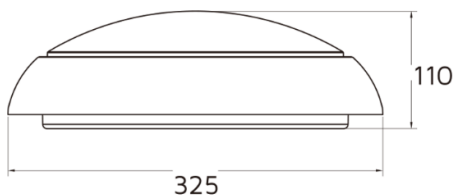
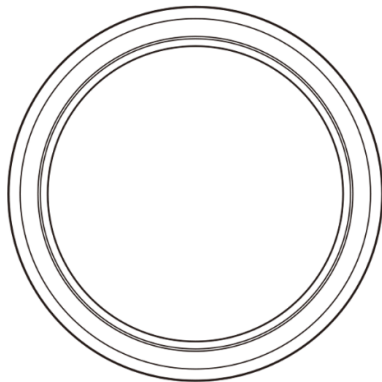

All units are in mm

Important Warranty Information

The LED Bulkhead has a 3 Year Warranty. The registrant must provide the product part number and date of manufacture, which can be found on the label attached to the Luminaire housing along with the original invoice. The Battery has a 1 Year Warranty.



Certificate No. FS 590684



Certificate No. EMS 590685

NET LED Lighting
Buckingway Business Park
300 Anderson Road
Cambridge
CB24 4UQ
sales@netled.co.uk
www.netled.co.uk

Technical Helpline: 01223 851505
Email: support@netled.co.uk
www.netled.co.uk/downloads

Manufactured by



DUXFORD LED BULKHEAD INSTALLATION GUIDE

Part Number	Description
NET-33-06-20	Tri-colour - Standard
NET-33-06-30	Tri-colour - Emergency
NET-33-06-25	Tri-colour - Self Test EMG
NET-33-06-24	Tri-colour - Motion Sensor
NET-33-06-34	Tri-colour - Motion Sensor EMG
NET-33-06-27	Tri-colour - Motion Self Test EMG
NET-33-06-70	Tri-colour - Photocell
NET-33-06-71	Tri-colour - Photocell EMG
NET-33-06-48	Tri-colour - Photocell Motion
NET-33-06-49	Tri-colour - Photocell Motion EMG
NET-33-06-40	4K - Standard
NET-33-06-42	4K - Emergency
NET-33-06-45	4K - Self Test Emergency
NET-33-06-44	4K - Motion Sensor
NET-33-06-46	4K - Motion Sensor Emergency
NET-33-06-47	4K - Motion Sensor Self Test EMG

SUPPLY/EARTH CLASS

220-240V AC 50/60 Hz



Fig.1 Mains Input Termination

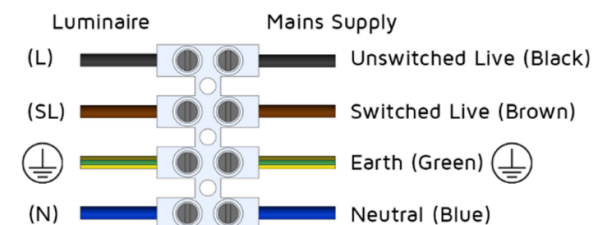

Installation procedure: Carefully read the installation instructions and ensure the mains supply is isolated before installation. Please read the safety information overleaf before carrying out any installation. Please retain this leaflet for future reference.

Bulkhead installation:

Replaceable (LED only) light source by professional Replaceable control gear by professional

Step 1: Hold down the Bulkhead and rotate the Outer Ring anti-clockwise to remove it. Then remove the Diffuser.

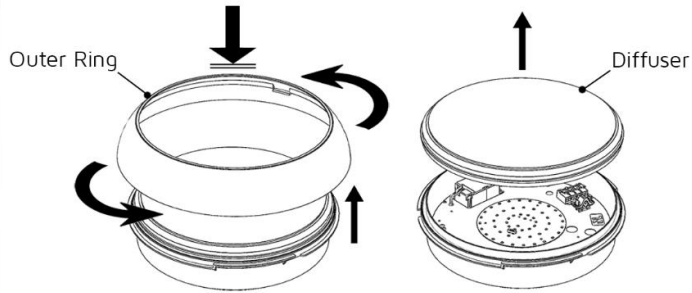

Step 2: Remove the Gear Tray from the housing by loosening the quick release screws. Drill out the screw holes in the housing and screw it into a solid surface using suitable wall plugs and screws.

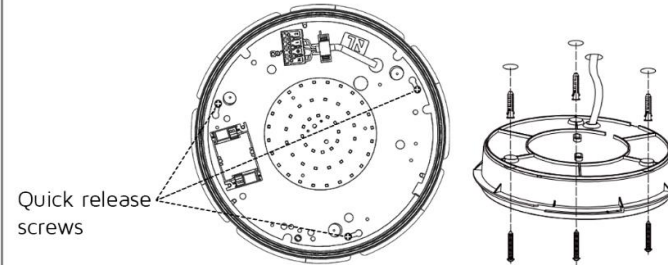

Step 3: Wire the Gear Tray as per the diagram below.

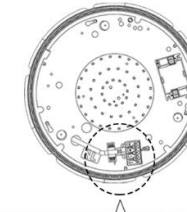

Note: A qualified electrician is required to carry out the electrical wiring. All wiring must be double insulated where there is a possibility of coming in contact with live wires.

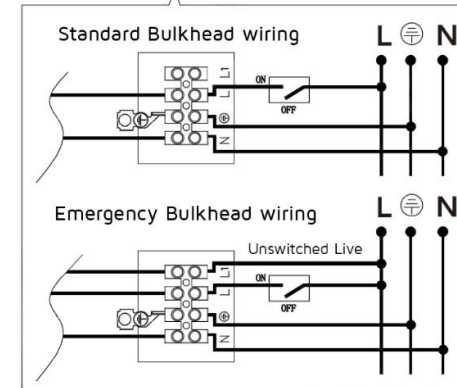

Step 4: Re-insert the Gear Tray into the housing and secure the power cable. Refit the Diffuser and switch on the mains to test that Bulkhead functions correctly.

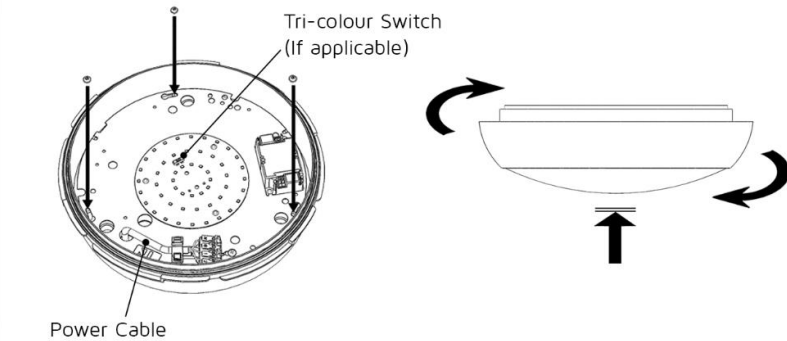

Photocell Sensor Configuration (Only for units with the Photocell Sensor option:

Night/Light Sensor Function

	1	2	3	4	open	close
I	ON	ON	ON	ON	5Lux	25Lux
II	ON	ON	ON	-	10Lux	50Lux
III	ON	ON	-	ON	25Lux	75Lux
IV	ON	ON	-	-	50Lux	100Lux
V	ON	-	ON	-	100Lux	200Lux
VI	ON	-	-	-	150Lux	300Lux
VII	-	ON	-	-	200Lux	400Lux
VIII	-	-	-	-	-	Disable

ON

When ambient light level is below the open lux level, the sensor automatically switches on luminaire at 100% brightness. When ambient level is over close lux level, the luminaire switches off.

Important Battery Warranty information

The Battery has a 1 Year Warranty. To claim, you must provide the product part number and date of manufacture, which can be found on the label attached to the Luminaire housing along with the original purchase invoice.



Microwave Motion Sensor Configuration: These settings are only for the LED Gear Tray with Microwave Sensor option.



Please note: Dip switch in the 'Up' position is ON.

Detection Area			Full Brightness Hold Time			Daylight Sensor			10% Corridor Function Time		
ch1	ON	100%	ch3	ON	5S	ch5	ON	Disable	ch7	ON	Off/OS
ch2	ON		ch4	ON		ch6	ON		ch8	ON	
ch1	-	75%	ch3	-	90S	ch5	-	50Lux	ch7	-	30S
ch2	ON		ch4	ON		ch6	ON		ch8	ON	
ch1	ON	50%	ch3	ON	3min	ch5	ON	15Lux	ch7	ON	10min
ch2	-		ch4	-		ch6	-		ch8	-	
ch1	-	25%	ch3	-	10min	ch5	-	5Lux	ch7	-	Always On/+∞
ch2	-		ch4	-		ch6	-		ch8	-	